



# HYDRAFORCE

High Performance Hydraulic Cartridge Valves  
and Electro-Hydraulic Control Systems



NEW  
***HYPERFORMANCE***<sup>™</sup>  
HIGH PRESSURE VALVES

# HYPERFORMANCE™

H-Series High Pressure Valves

up to 350 bar / 5075 psi

HydraForce, the world's leading supplier of cartridge valve technology, introduces the new HyPerformance valve series.

These valves are designed to offer the industry's highest level of valve performance, enabling the most reliable application of cartridge technology in high duty cycle, high horsepower and high pressure machine applications.



## *New H-Series HYPERFORMANCE Valves*

The new H-Series HyPerformance™ valves supplement the high-pressure standard valves currently released in the HydraForce catalog. H-Series valves are differentiated by the heavy duty qualification test standard (NFPA T 2.6.1) and the new cavity specification.

### FEATURES:

- 350 bar/5075 psi continuous operating pressure.
- 420 bar/6090 psi intermittent 10% duty cycle tested.
- Fatigue tested to 420 bar/6090 psi for 2 million cycles.
- Flows up to 379 lpm/100 gpm.
- 1000 hour salt spray tested.
- IP69K rated solenoid coils.
- Single-piece, high endurance PPDI Urethane seals rated to 135°C (275°F)
- Vibration tested (3-axis) to 20G RMS.

### BENEFITS:

High installation torque improves reliability under heavy duty cycle conditions.

Single-piece urethane seals eliminate back-up rings and improve ease-of-installation. Optional fluorocarbon seals with back-up rings are available.

Modified cavity with bottom shoulder, enhances strength and prevents twisting or binding during installation, assuring accurate and consistent performance.

All High Performance Products are tested to the rigorous NFPA T 2.6.1 standard of 900K cycles at 350 bar/5075 psi and 100K at 420 bar/6090 psi to ensure long-life and superior performance throughout the life of your machine.

# HYPERFORMANCE™

## H-Series High Pressure Valves

up to 350 bar / 5075 psi

### *HYPRESSURE* Reliability

- H-Series valves are qualified at 1 million cycles at 350 bar / 5075 psi with pressure excursions to 420 bar / 6090 psi for 10% of the duty cycle.
- Burst Pressure tested up to 1379 bar/20,000 psi.
- Fatigue tested to 420 bar for 2 million cycles.

### *HYPERFORMANCE* Cavity

- H-Series valves use a modified standard cavity with a bottom shoulder to support the cage.
- The valve cage is clamped between the adapter and the bottom shoulder in order to strengthen the pressure holding capability of the cartridge.
- The cavity profile is the same as the standard HydraForce profile with the exception of the bottom shoulder. A revised form tool is required in order to control the shoulder depth.

### *HYPERFORMANCE* Construction

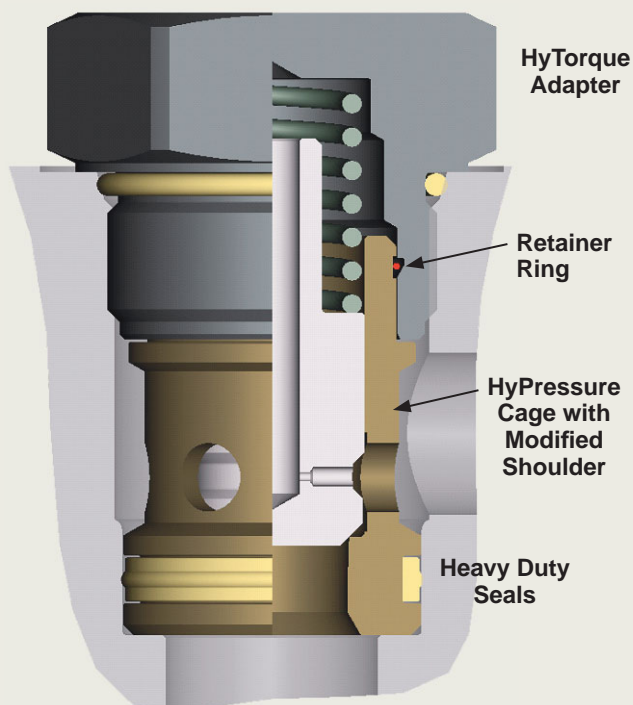

Please consult the individual valve catalog pages for details on torque and cavity interchangeability.

### *HYFLOW* – *HYHORSEPOWER*

- H Series valves will be released as a family of products ranging from the -08 common cavity size to the metric -42 cavity with flow ratings up to 379 lpm/100 gpm.

### *HYSTRENGTH* Sealing

- High strength, high temperature rated PPDI Urethane seals provide reliability under heavy duty cycle operation.
- Back-up rings are eliminated providing an easier and more reliable installation.
- Fluorocarbon seals are optional with Teflon® back-up rings.

### *HYTORQUE* Installation

- Installation torques of 3 to 4 times standard screw-in cartridges prevents back-out under heavy cyclic high pressure operation.
- The valve cage is retained in, but not fixed to the adapter in order to prevent distortion or binding during installation.

### *HYVIBRATION* Tolerance

- Valve coils and stem tubes are tested to a 20G RMS 3-axis profile assuring reliability in severe mobile machinery applications.

### *HY-COIL* Integrity

- HydraForce coils are designed for continuous operation at +/- 15% of rated voltage assuring reliable and safe operation under cold temperature, weak battery, and continuous duty conditions.
- E and H Series IP 69K Coils are tested for severe application conditions including thermal shock, water immersion, vibration, dust, high pressure cleaning, severe load cycling, extreme storage temperatures, chemical resistance and humidity.
- H Series valves used with H Series coils provide 1000-hour salt spray protection against red rust corrosion.

# HYPERFORMANCE™

High Pressure Product Line

up to 350 bar / 5075 psi

## High Pressure Solenoid Valves

### N.C. Poppet

Std. **SF08-20**  
27 lpm/7 gpm

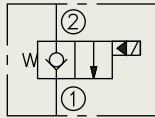

HyP **HSV10-20**  
75 lpm/20 gpm  
Mid 2010

### N.O. Poppet

Std. **SF08-21**  
39 lpm/10 gpm

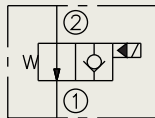

HyP **HSV10-21**  
75 lpm/20 gpm  
Mid 2010

### N.C. Reverse Flow

Std. **SF08-22**  
23 lpm/6 gpm

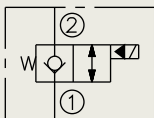

### N.O. Reverse Flow

Std. **SF08-23**  
30 lpm/8 gpm

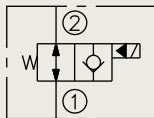

### N.C. Spool

HyP **HSV10-24**  
30 lpm/8 gpm  
Mid 2010

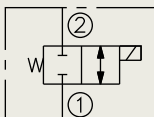

### N.O. Spool

HyP **HSV10-25**  
30 lpm/8 gpm  
Mid 2010

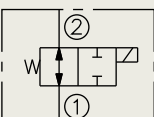

### N.C. Blocking/ Poppet

HyP **HSV10-28**  
76 lpm/20 gpm  
Mid 2010

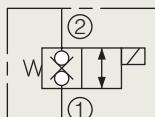

## High Pressure Solenoid Valves (cont'd.)

### N.O. Blocking/ Poppet

HyP **HSV10-29**  
76 lpm/20 gpm  
Mid 2010

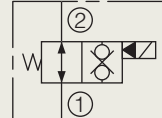

### 3-Way Spool

Std. **SV58-30**  
15.1 lpm/4 gpm

HyP **HSV10-30**  
22 lpm/5.8 gpm  
Late 2010

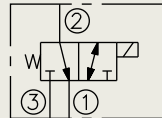

### 4-Way N.O. Spool

Std. **SV58-40**  
11 lpm/3 gpm

HyP **HSV10-40R**  
22 lpm/5.8 gpm  
Mid 2010

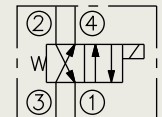

### 4-Way N.C. Spool

Std. **SV58-41**  
17 lpm/4.5 gpm

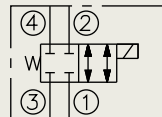

### 4-Way 3-Position Spool

HyP **HSV10-47**  
22 lpm/5.8 gpm  
Late 2010

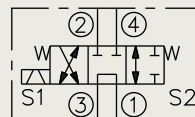

## High Pressure Electro-Proportional Valves

### Proportional Directional 2-Way, N.C.

HyP **HSP16-20**  
227 lpm/60 gpm  
Mid 2010

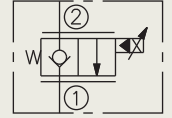

### Proportional Flow Control, Restrictive, N.C.

HyP **HPV12-20**  
64 lpm/17 gpm  
Mid 2010

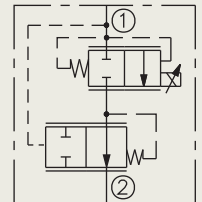

### Proportional Flow Control, Bypass, N.C.

HyP **HPV12-30**  
64 lpm/17 gpm  
Mid 2010

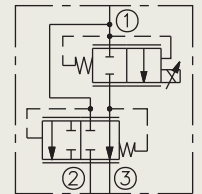

### HyP HPV16-30

151 lpm/40 gpm  
Late 2010

### Proportional Flow Control, Bypass, N.O.

HyP **HPV16-31**  
79 lpm/21 gpm  
Late 2010

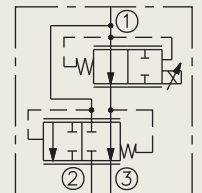

### Proportional Pressure Control

Std. **TS58-20**  
7.6 lpm/2 gpm

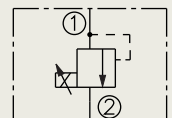

### Proportional Pressure Control

Std. **TS58-21F**  
1.9 lpm/0.5 gpm

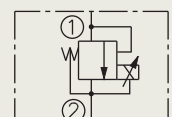

Valves labeled "Std." utilize standard HydraForce valve cavities, are rated at 345 bar/5000 psi, and are available now.

# HYPERFORMANCE™

High Pressure Product Line

up to 350 bar / 5075 psi

## High Pressure Check & Directional Valves

### Poppet, Check

Std. **CV50-20**  
57 lpm/15 gpm

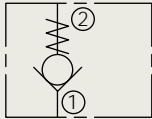

HyP **HCV16-20**  
151 lpm/39 gpm  
Available Now

HyP **HCV42-M20**  
302 lpm/80 gpm  
Available Now

### Shuttle

Std. **LS50-30**  
30 lpm/8 gpm

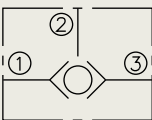

### Hot Oil Shuttle

Std. **HS50-42**  
22 lpm/6 gpm

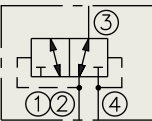

Std. **HS52-42**  
114 lpm/30 gpm

### Hot Oil Shuttle

Std. **HS50-43**  
45 lpm/12 gpm

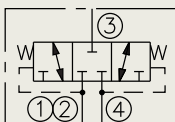

Std. **HS52-43**  
132 lpm/35 gpm

### Manual Shift Spring Return

Std. **MP58-30**  
25 lpm/6.5 gpm

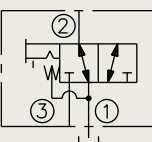

### 3-Way Directional

HyP **HPD42-M44**  
265 lpm/70 gpm  
Mid 2010

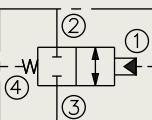

## High Pressure Directional Valves (cont'd.)

### 3-Way Directional

Std. **PD42-S50**  
265 lpm/70 gpm

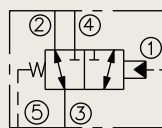

### 3-Way Directional

HyP **HPD42-S50**  
265 lpm/70 gpm  
Late 2010

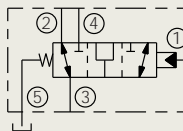

### 4-Way Directional

HyP **HPD42-S60**  
189 lpm/50 gpm  
Late 2010

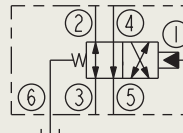

### 4-Way 3-Pos. N.O.

HyP **HPD42-S67B**  
150 lpm/40 gpm  
Late 2010

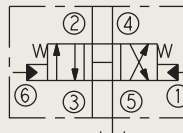

### 4-Way 3-Pos. N.C.

HyP **HPD16-S67C**  
95 lpm/25 gpm  
Late 2010

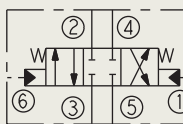

## High Pressure Proportional Directional Valves

### 4-Way 3-Pos. N.C. Pilot-Operated

HyP **HPE16-S67C**  
90 lpm/24 gpm  
Late 2010

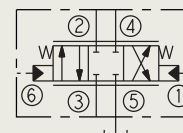

### HyP HPE42-S67C

150 lpm/40 gpm  
Late 2010

## High Pressure Proportional Directional Valves (cont'd.)

### 2-Way N.C. Pilot-Operated

HyP **HPE42-M44**  
265 lpm/70 gpm  
Late 2010

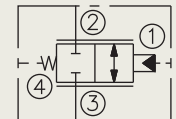

### 2-Way N.O. Pilot-Operated

HyP **HPE42-M45**  
265 lpm/70 gpm  
Late 2010

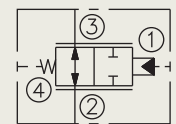

### 3-Position N.O. Pilot-Operated

HyP **HPE42-S67B**  
150 lpm/40 gpm  
Late 2010

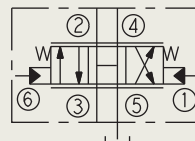

### 3-Position N.C. Pilot-Operated

HyP **HPE42-S67C**  
150 lpm/40 gpm  
Late 2010

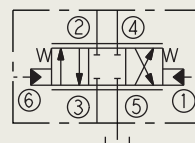

### Pilot-Operated Meter-in and Meter-Out

HyP **HPE42-S67D**  
170 lpm/45 gpm  
Late 2010

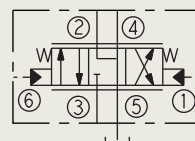

### 3-Position Pilot-Operated

HyP **HPE42-S67H**  
150 lpm/40 gpm  
Late 2010

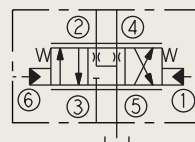

### Pilot-Operated Meter-Out Only

HyP **HPE42-S67K**  
170 lpm/45 gpm  
Late 2010

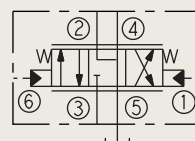

Valves labeled "Std." utilize standard HydraForce valve cavities, are rated at 345 bar/5000 psi, and are available now.

### High Pressure Vented Logic Elements

#### Vented Logic

Std. **EV10-S34**  
76 lpm/20 gpm

Std. **EV12-S34**  
113 lpm/30 gpm

HyP **HEV16-S34**  
189 lpm/50 gpm  
Mid 2010

Std. **EV20-S34**  
379 lpm/100 gpm

HyP **HEV42-S34**  
379 lpm/100 gpm  
Available Now

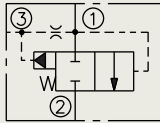

### High Pressure Piloted Logic Elements (cont'd.)

#### Pressure Compensating

Std. **EPFR58-35**  
38 lpm/10 gpm

Std. **EPFR50-S35**  
76 lpm/20 gpm

Std. **EPFR52-S35**  
151 lpm/40 gpm

#### Pilot-to-Close

HyP **HEP16-S35**  
189 lpm/50 gpm  
Mid 2010

#### Poppet Logic

Std. **EP10-S38**  
113 lpm/30 gpm

#### Checked Logic

HyP **HEP42-S39**  
284 lpm/75 gpm  
Available Now

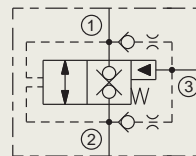
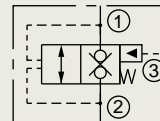
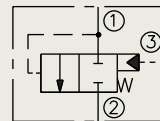
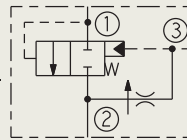

### High Pressure Flow Controls

#### Pressure Compensated, Fixed

Std. **FR50-20F**  
22.7 lpm/6 gpm

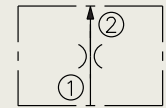

#### Pressure Compensated, Adjustable

Std. **FR50-23**  
11.5 lpm/3 gpm

Std. **FR50-28**  
34 lpm/9 gpm

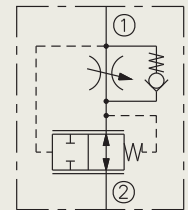

#### Pressure Compensator with Load Sense

HyP **HEC32-43**  
303 lpm/80 gpm  
Late 2010

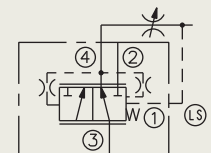

#### Divider/Combiners

Std. **FD50-45**  
19 lpm/5 gpm

Std. **FD52-45**  
38 lpm/10 gpm

Std. **FD56-45**  
53 lpm/14 gpm

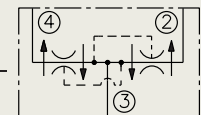

### High Pressure Piloted Logic Elements

#### Piloted Logic

Std. **EP08-35**  
38 lpm/10 gpm

Std. **EP10-S35**  
76 lpm/20 gpm

Std. **EP12-S35**  
113 lpm/30 gpm

Std. **EP20-S35**  
379 lpm/100 gpm

HyP **HEP42-S35**  
379 lpm/100 gpm  
Available Now

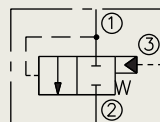

Valves labeled "Std." utilize standard HydraForce valve cavities, are rated at 345 bar/5000 psi, and are available now.



### High Pressure Pressure Controls

#### Direct-Acting Poppet

Std. **RV58-20**  
22 lpm/6 gpm

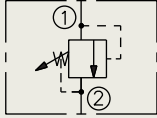

#### Dynamic Relief

Std. **RVD50-20**  
113 lpm/30 gpm

#### Differential Area Poppet

Std. **RV50-22**  
75 lpm/20 gpm

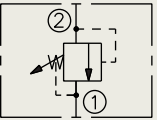

#### Pilot-Operated Spool

Std. **RV50-26**  
113 lpm/30 gpm

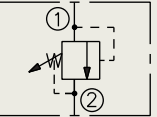

Std. **RV52-26**  
379 lpm/100 gpm

#### Pressure Reducing/Relieving

Std. **PRES50-30**  
11.4 lpm/3 gpm

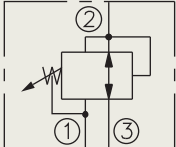

### High Pressure Pressure Controls (cont'd.)

#### Pressure Reducing Pilot Element

Std. **ER10-S30**  
68 lpm/18 gpm

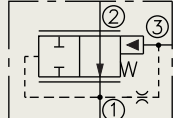

Std. **ER12-S30**  
114 lpm/30 gpm

#### Sequence, Pilot-Operated

Std. **PS50-36**  
57 lpm/15 gpm

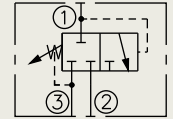

#### Sequence, Normally Closed

Std. **PS50-40**  
22 lpm/6 gpm

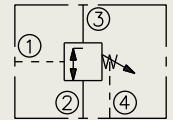

#### Reducing/Relieving, Pilot Operated

Std. **PR50-36**  
56 lpm/15 gpm

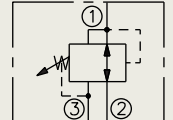

#### Reducing/Relieving, Direct-Acting

Std. **PR58-38**  
19 lpm/5 gpm

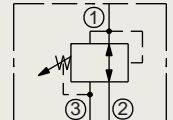

Std. **RV50-38**  
72 lpm/19 gpm

#### Thermal Relief

Std. **TR04-B20**

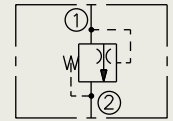

Valves labeled "Std." utilize standard HydraForce valve cavities, are rated at 345 bar/5000 psi, and are available now.



Main headquarters, engineering and manufacturing facility in Lincolnshire Illinois, just north of Chicago.



Precision machining facility in Lincolnshire, Illinois.



European headquarters, engineering and manufacturing facility in Birmingham, England.

Request our complete engineering catalog, available on CD-ROM or printed edition.  
Updates and complete technical information are always available on our website: [www.hydraforce.com](http://www.hydraforce.com)

# HYDRAFORCE

Visit our website: [www.hydraforce.com](http://www.hydraforce.com)  
From North America Call Toll Free: 1 800 682 6875

**HYDRAFORCE INC**  
500 Barclay Blvd.  
Lincolnshire, IL 60069  
Phone: 847 793 2300  
Fax: 847 793 0086

Member: National Fluid Power Assoc.  
ISO 9001

**HYDRAFORCE HYDRAULICS LTD**  
St. Stephens Street  
Birmingham B6 4RG England  
Phone: 0121 333 1800  
Fax: 0121 333 1810

Member: British Fluid Power Assoc.  
ISO 9001 & ISO 14001

**HYDRAFORCE CHINA LLC**  
Shanghai Representative  
Office Unit 606, B&W Tower  
No. 28 Xuanhua Rd  
Shanghai, 200050, China  
Tel: +86 21 3250 6508, 3250 6509  
Fax: +86 21 3250 6510  
Email: [khuang@hydraforce.com](mailto:khuang@hydraforce.com)

**HYDRAFORCE KOREA LLC**  
#306, Mirim Plaza  
1132-1, Jungdong, Wonnigu,  
Bucheon, Kyunggido, Korea  
Tel: +82 32 328 2170  
Fax: +82 32 328 2172  
Email: [jong-seongl@hydraforce.com](mailto:jong-seongl@hydraforce.com)

**HYDRAFORCE HYDRAULICS - INDIA**  
Vatika Business Centre  
Suite No. 22, Level 5, C Wing  
Techpark One, Airport Road  
Yerwada, Pune 411006  
Maharashtra, India  
Tel: +91 020 40111304  
Fax: +91 020 40111105  
Email: [bharatb@hydraforce.com](mailto:bharatb@hydraforce.com)



HydraForce valves meet RoHS environmental requirements restricting the use of cadmium, quick silver, lead hexavalent chrome, polybrominated biphenyl (PPB) or polybrominated diphenyl Ester (PPDE) in products, components and packing materials.  
All HydraForce products meet requirements limiting the use of hazardous materials as identified in OSHA Standard 1910.1200(g).